

# ALPS



# VILMERS

# ALPS



## Comfort

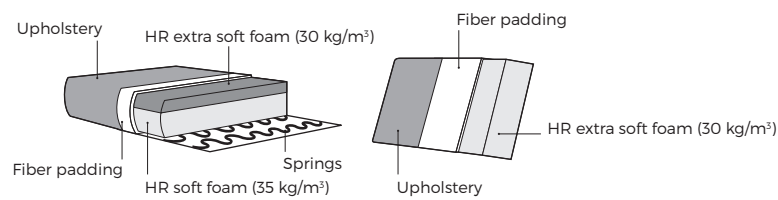

## 1. Upholstery

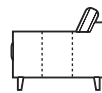
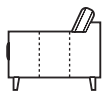

Leather \*

Fabric

\* Leather and fabric upholstery contain the same number of stitches.

## 2. Legs

3 cm



282  
Oiled



Black



323  
Metal



152  
Plastic

### IMPORTANT:

Upholstered furniture is handmade using soft materials, therefore measurements can vary in all modules by up to **+/-2 cm**.  
Modules and combinations shown in 2D drawings are left-sided. Modules and combinations can be mirrored from left to right.

## Modules

Scale 1:100

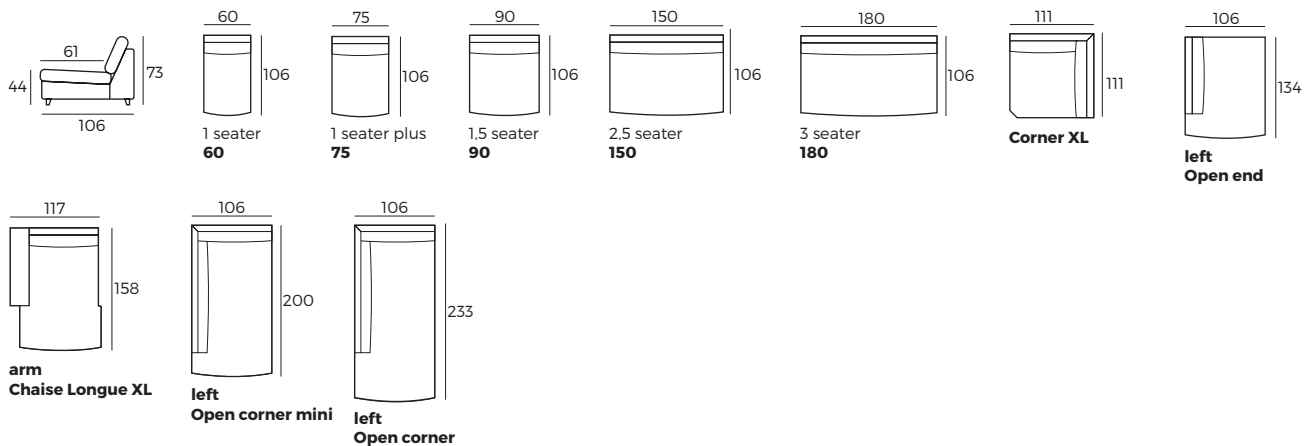

# ALPS

## Modules with armrest

Scale 1:100

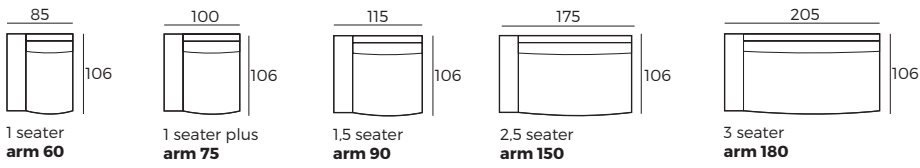

## Combinations

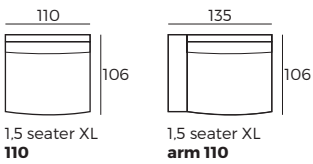
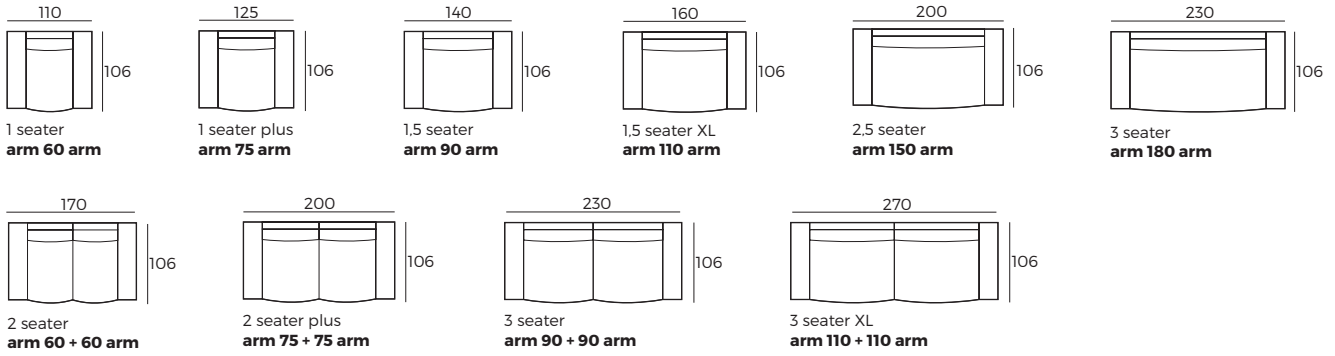

This module can only connect with each other.  
For example arm 110+110+110 arm

## Accessories

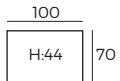

**Footstool**  
100x70