

ALTE



VILMERS

ALTE



Comfort

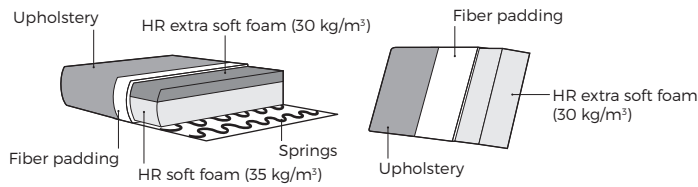

1. Upholstery

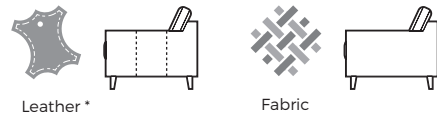

* Leather upholstery may require more stitches than fabric upholstery.

2. Headrest type

* Measurements for fully opened mechanism.

1 Manual ↻

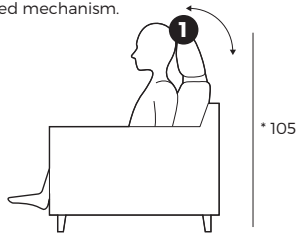

3. Armrest

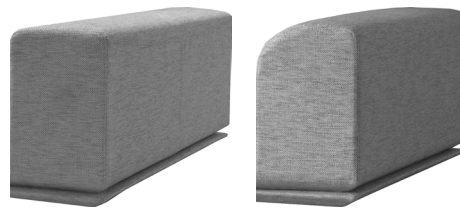

ALTE
W 26 x D 105 x H 43

PATH
W 26 x D 105 x H 43

4. Legs



IMPORTANT:

Upholstered furniture is handmade using soft materials, therefore measurements can vary in all modules by up to **+/-2cm**.
Modules and combinations shown in 2D drawings are left-sided. Modules and combinations can be mirrored from left to right.

Modules (Measurements with ALTE armrest)

Scale 1:100

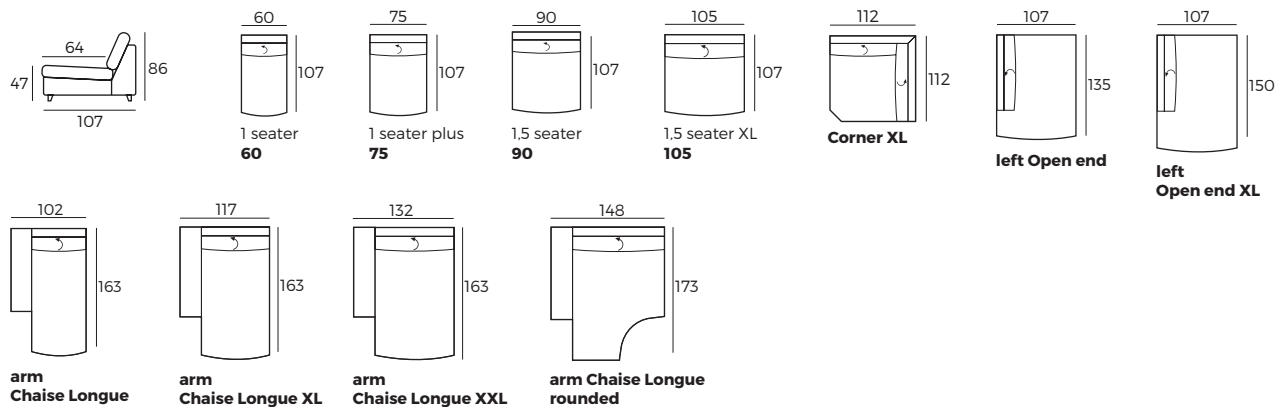

ALTE

Modules with armrest (Measurements with ALTE armrest)

Scale 1:100

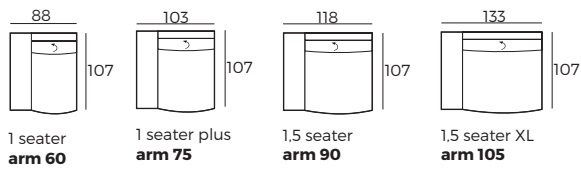

Combinations (Measurements with ALTE armrest)

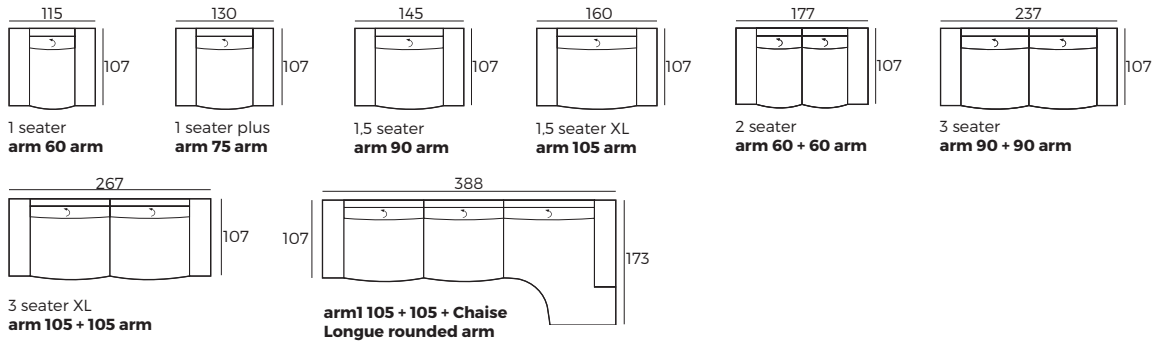

Accessories

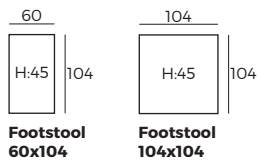

)- manual: