

FLYER



VILMERS

FLYER



Comfort

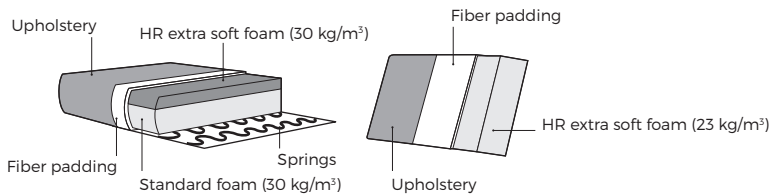

1. Upholstery

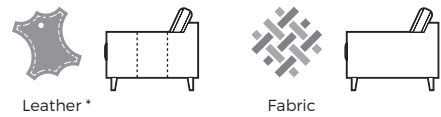

* Leather upholstery may require more stitches than fabric upholstery.

2. Headrest & seat type

* Measurements for fully opened mechanism.

- 1 Manual ↗ / Electrical ⌂
- 2 Electrical ⌂

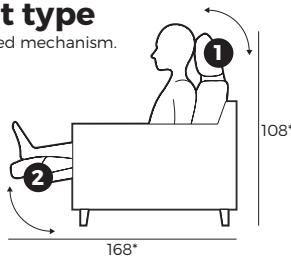

3. Armrest function



Fully closed W 11 x D 98 x H 66
Fully opened W 23 x D 98 x H 51

4. Multicolour option



5. Legs



IMPORTANT:

Upholstered furniture is handmade using soft materials, therefore measurements can vary in all modules by up to **+/-2 cm**.
 Modules and combinations shown in 2D drawings are left-sided. Modules and combinations can be mirrored from left to right.

Modules (Measurements with fully opened armrest)

Scale 1:100

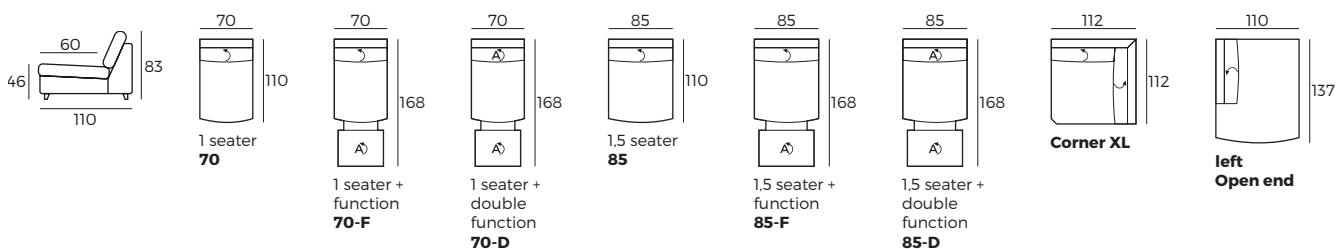

FLYER

Modules (Measurements with fully opened armrest)

Scale 1:100

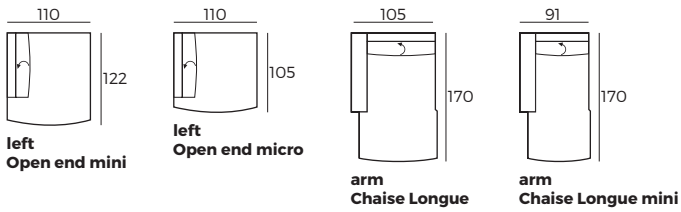

Modules with armrest (Measurements with fully opened armrest)

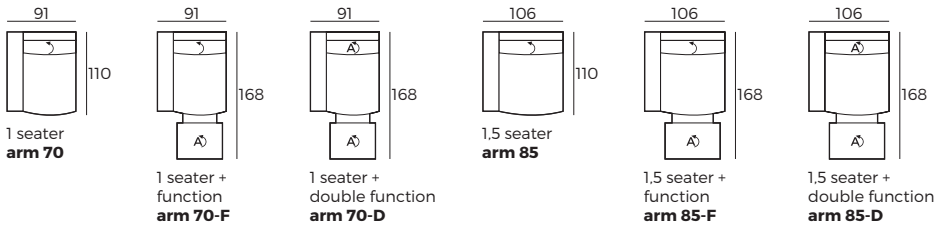

Combinations (Measurements with fully opened armrest)

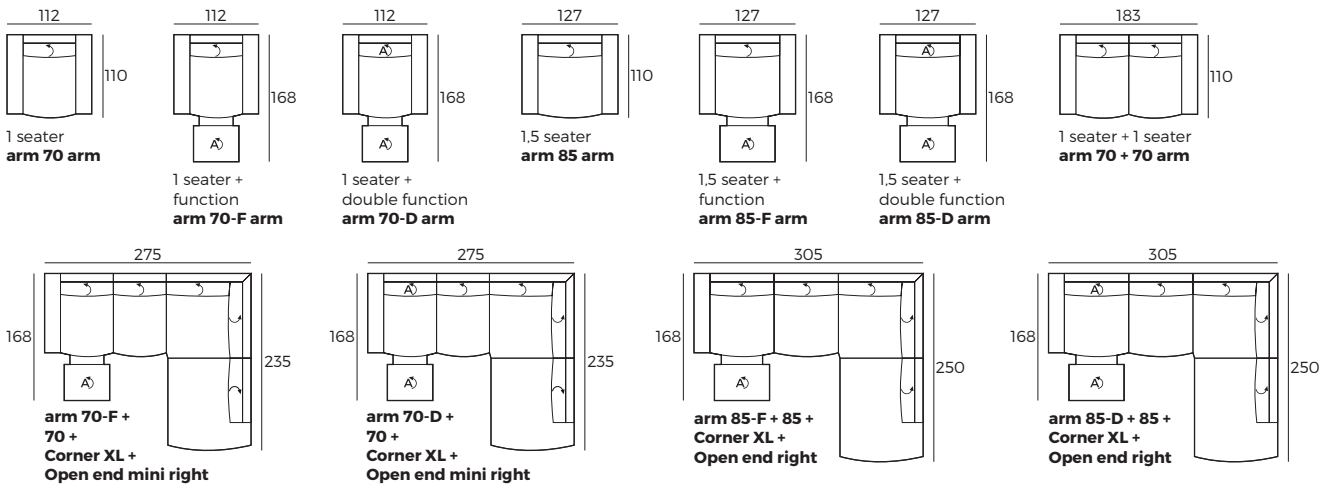

Accessories

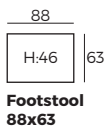

↶ - manual; ↷ - electrical *F - single electric function; *D - double electric function