

# GÖTEBORG

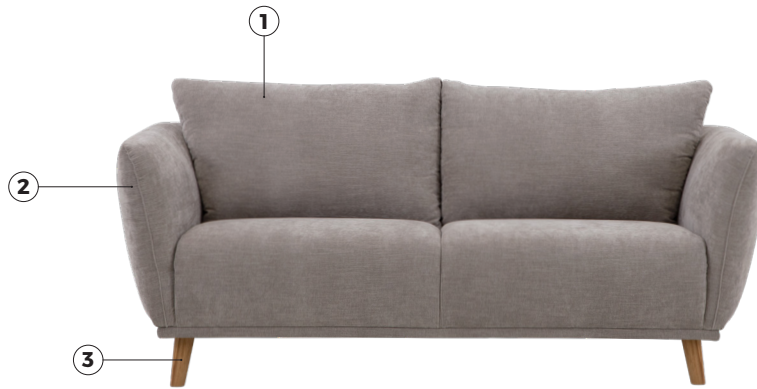

# VILMERS

# GÖTEBORG



## Comfort

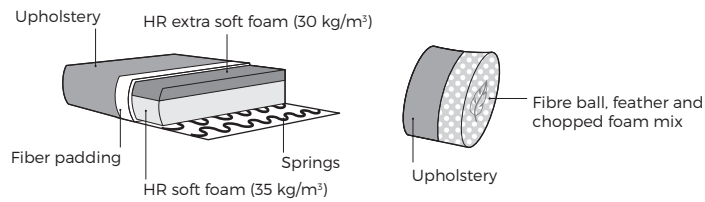

## 1. Upholstery

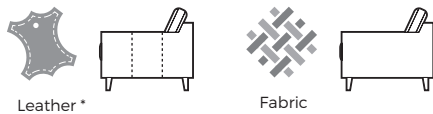

\* Leather upholstery may require more stitches than fabric upholstery.

## 2. Choose cushions

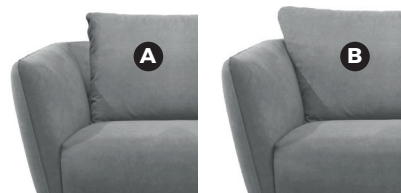

## 3. Legs



### IMPORTANT:

Upholstered furniture is handmade using soft materials, therefore measurements can vary in all modules by up to **+/-2 cm**.  
Modules and combinations shown in 2D drawings are left-sided. Modules and combinations can be mirrored from left to right.

## Modules

Scale 1:100

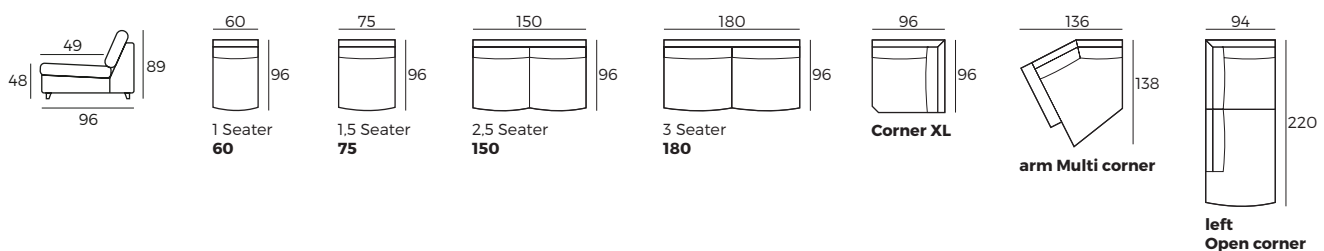

# GÖTEBORG

## Modules

Scale 1:100

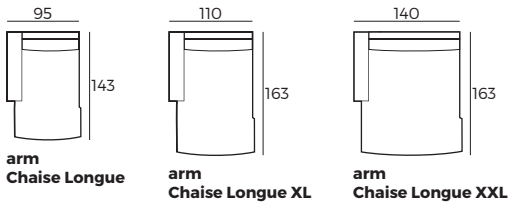

## Modules with armrest

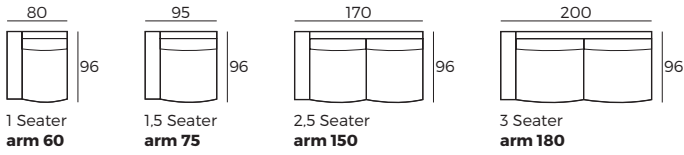

## Combinations

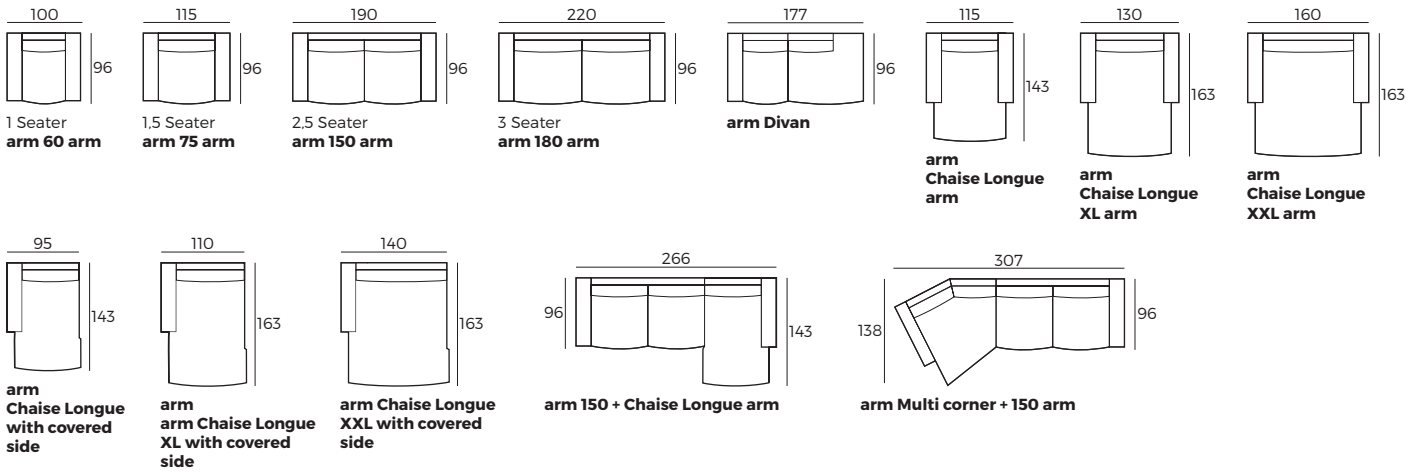

## Accessories

