

FLYER

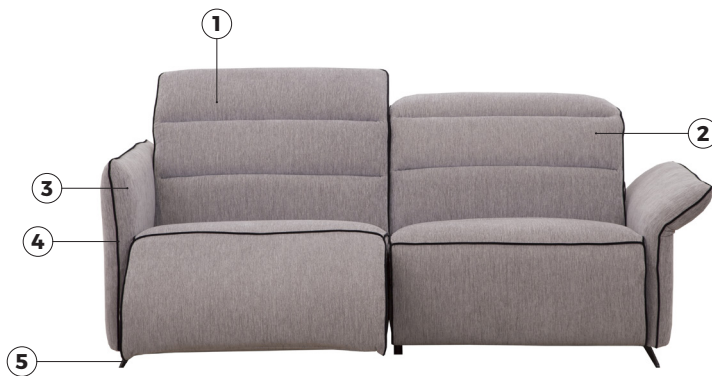

VILMERS

FLYER



Comfort

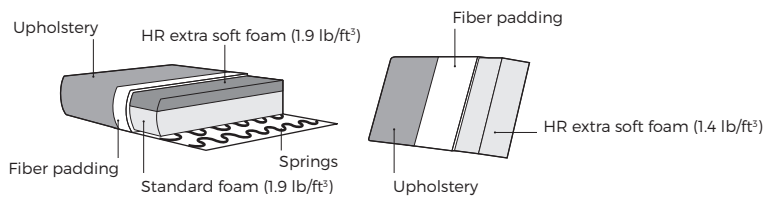

1. Upholstery

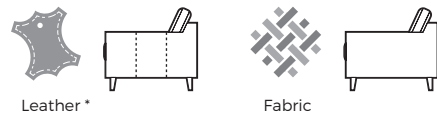

* Leather upholstery may require more stitches than fabric upholstery.

2. Headrest & seat type

*Measurements with fully opened mechanism

- 1 Manual ↶ / Electrical ⏻
- 2 Electrical ⏻

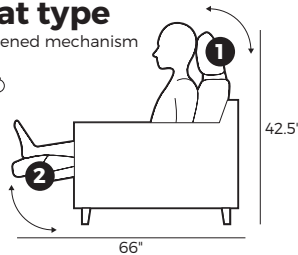

3. Armrest function



Fully closed W 4.5" x D 38.5" x H 26" **Fully opened** W 9" x D 38.5" x H 20"

4. Multicolour option



5. Legs



436
Metal

IMPORTANT:

Upholstered furniture is handmade using soft materials, therefore measurements can vary in all modules by up to +/- 1".
Modules and combinations shown in 2D drawings are left-sided. Modules and combinations can be mirrored from left to right.

Modules (Measurements with fully opened armrest)

Scale 1:100

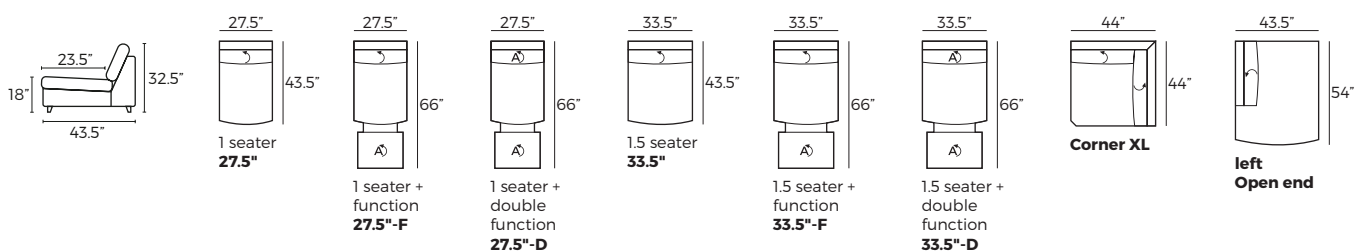

FLYER

Modules (Measurements with fully opened armrest)

Scale 1:100

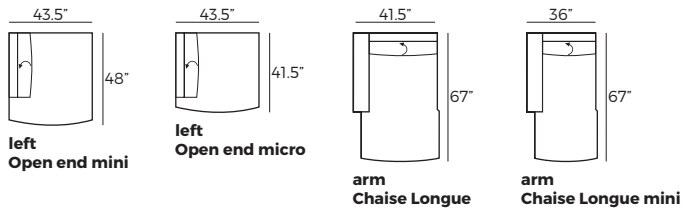

Modules with armrest (Measurements with fully opened armrest)

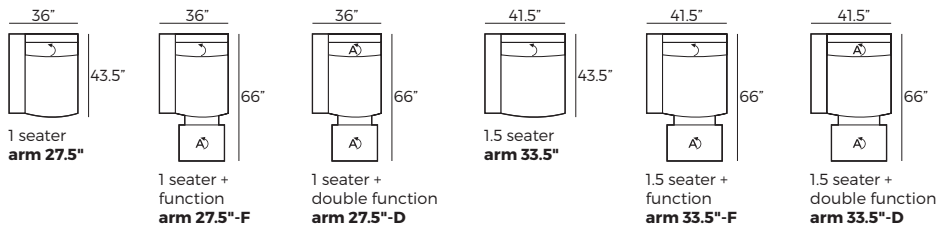

Combinations (Measurements with fully opened armrest)

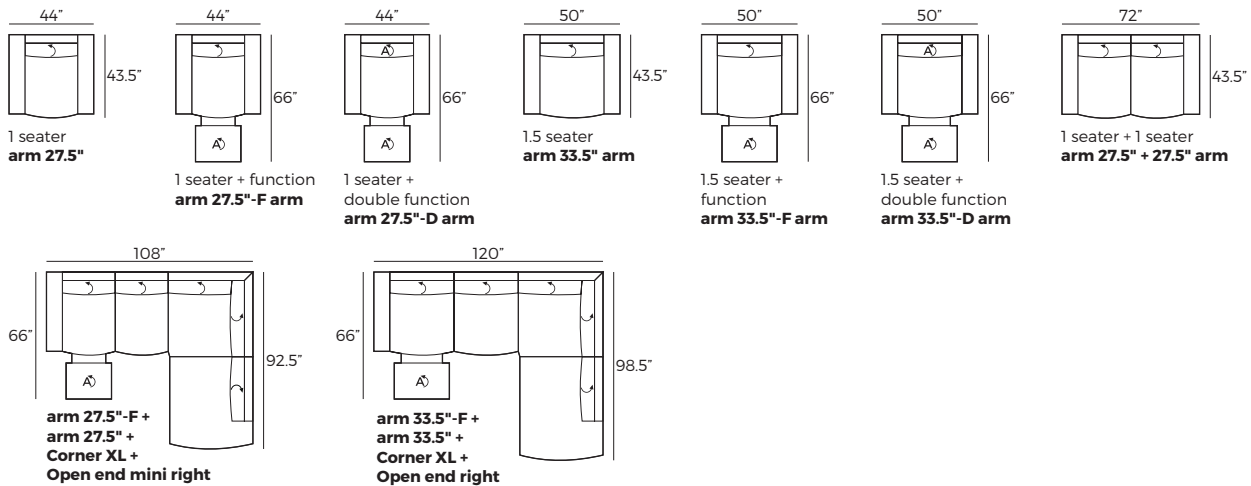

Accessories

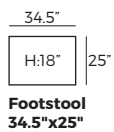

⌋ - manual; Ⓐ - electrical *F - single electric function; *D - double electric function