

JOANA



VILMERS

JOANA



Comfort

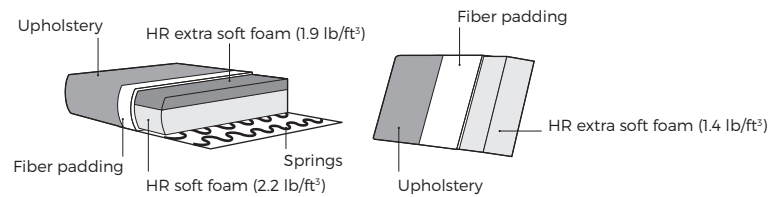

1. Upholstery



Leather *

Fabric

* Leather upholstery may require more stitches than fabric upholstery.

2. Headrest & seat type

* Measurements for fully opened mechanism.

- 1 Manual ↷
- 2 Electrical ⏻

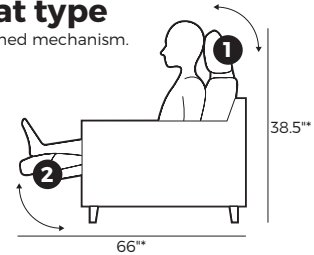

3. Armrest

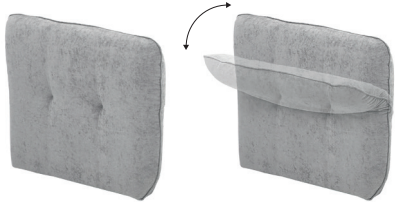

A Fully closed

W 4.5" x D 38.5" x H 26"

A Fully opened

W 9" x D 38.5" x H 20"

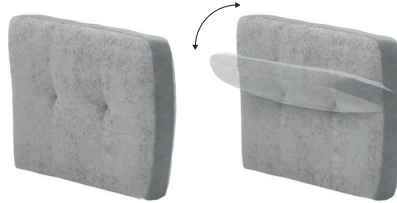

B Fully closed

W 4.5" x D 38.5" x H 66"

B Fully opened

W 9" x D 38.5" x H 20"

4. Legs



IMPORTANT:

Upholstered furniture is handmade using soft materials, therefore measurements can vary in all modules by up to +/- 1".
Modules and combinations shown in 2D drawings are left-sided. Modules and combinations can be mirrored from left to right.

Modules (Measurements with fully opened armrest)

Scale 1:100

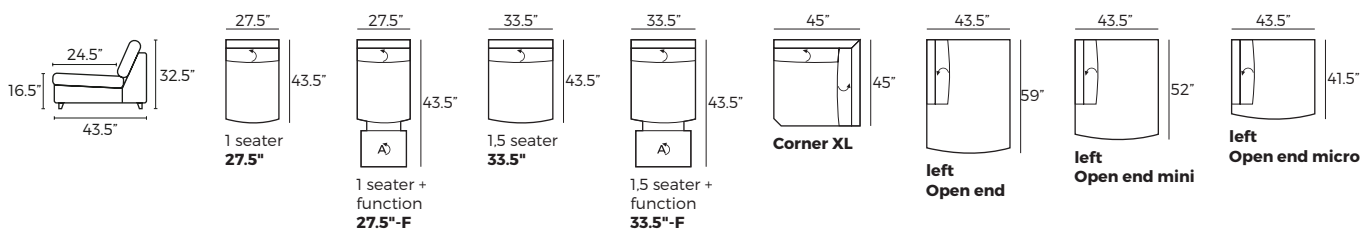

JOANA

Modules (Measurements with fully opened armrest)

Scale 1:100

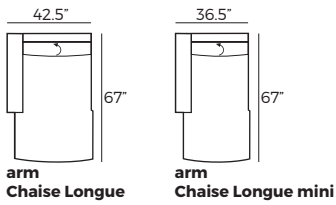

Modules with armrest (Measurements with fully opened armrest)

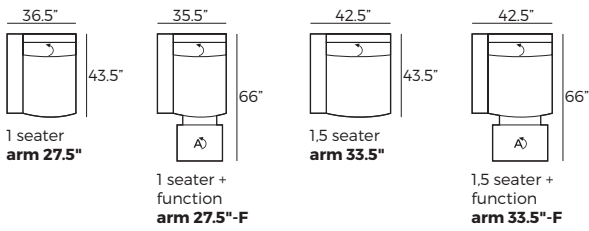

Combinations (Measurements with fully opened armrest)

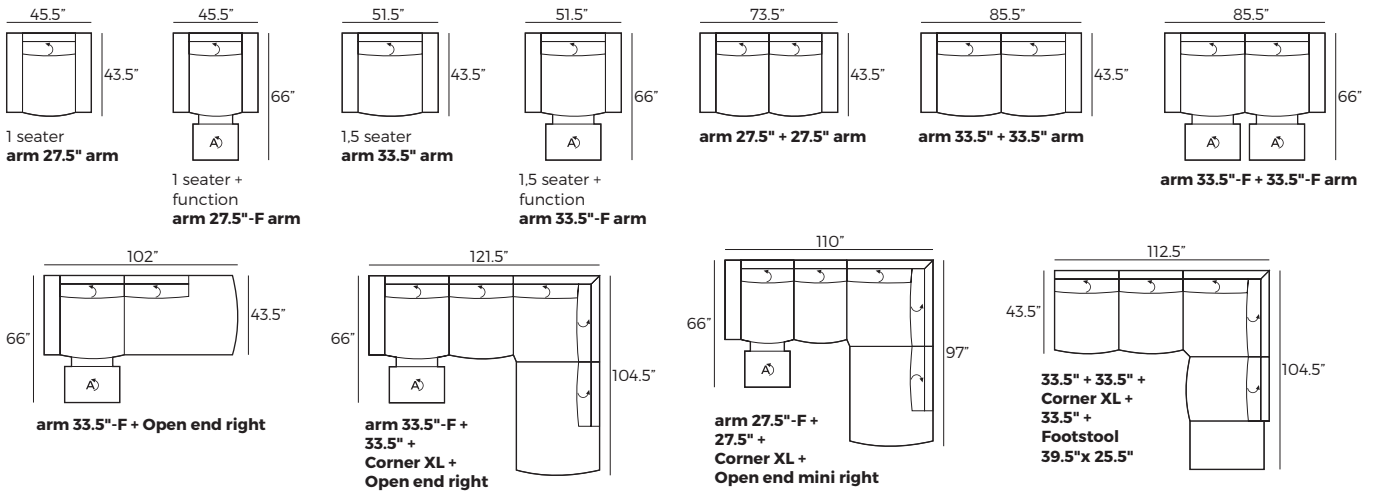

Accessories

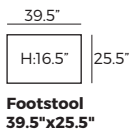

↶ - manual; Ⓜ - electrical *F - single electric function