

ALPINE



VILMERS

ALPINE



Functional



Comfort

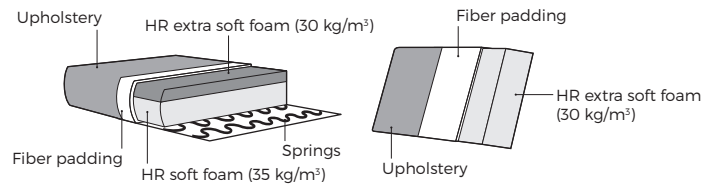

1. Upholstery



Fabric

2. Headrest & seat type

* Measurements for fully opened mechanism.

- 1 Manual ↶
- 2 Electrical ⚡

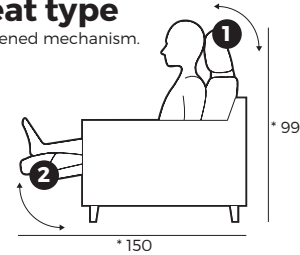

3. Multicolour option



4. Legs

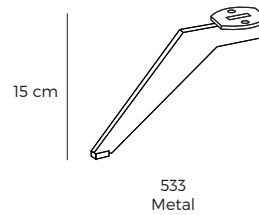

IMPORTANT:

Upholstered furniture is handmade using soft materials, therefore measurements can vary in all modules by up to **+/-2 cm**.
 Modules and combinations shown in 2D drawings are left-sided. Modules and combinations can be mirrored from left to right.
 For an additional fee, the sides of each seater module can be covered in fabric.

Modules

Scale 1:100

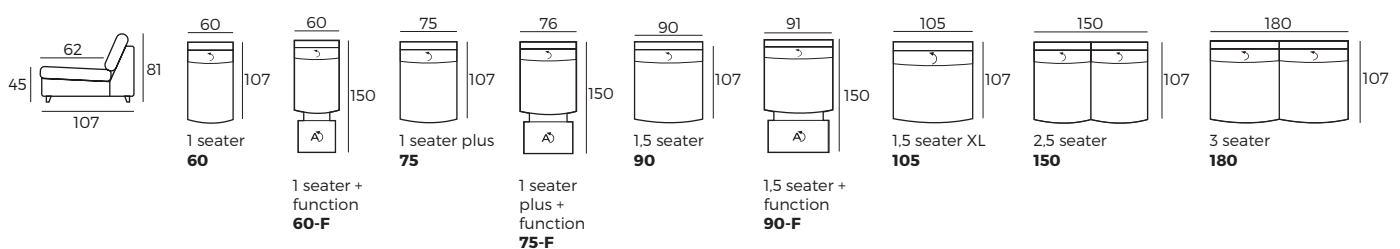

ALPINE

Modules

Scale 1:100

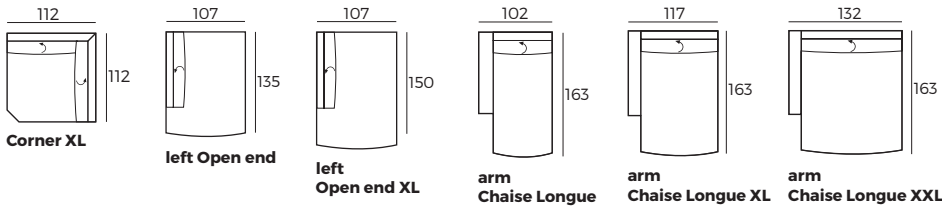

Modules with armrest

Scale 1:100

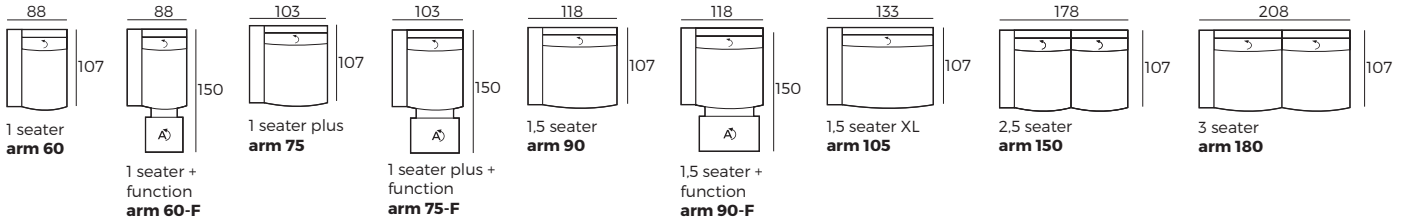

Combinations

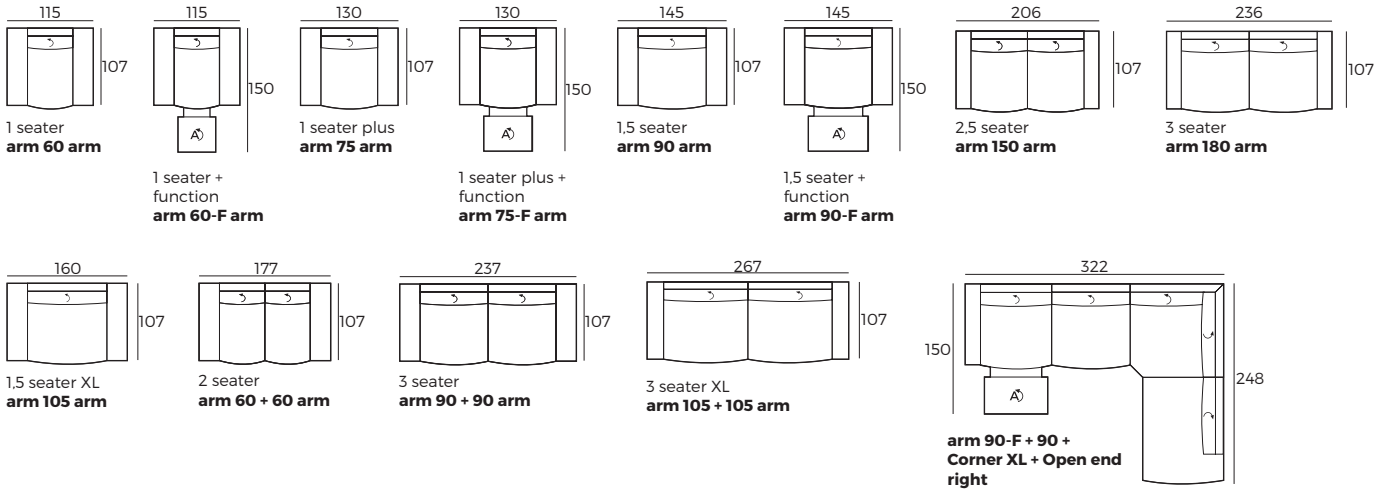

Accessories

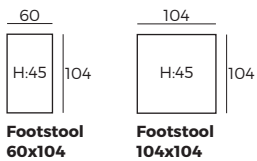

↷ - manual; ⚡ - electrical; *F - single electric function