

BLUEMARY



VILMERS

BLUEMARY



Loose
fit



Fix
cushions



Covered
sides



Comfort

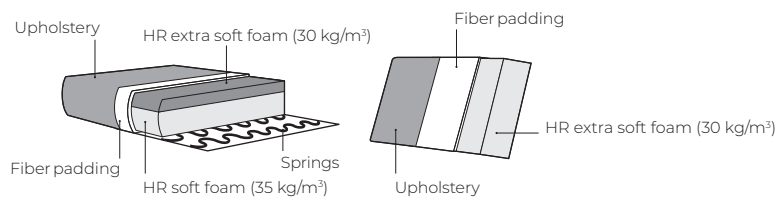

1. Upholstery



Leather*

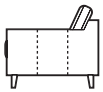

Fabric

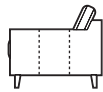

2. Legs



282
Oiled



Black



323
Metal



152
Plastic

* Leather and fabric upholstery contain the same number of stitches.

Upholstered furniture is handmade using soft materials, therefore measurements can vary in all modules by up to **+/-2cm**.
Modules and combinations shown in 2D drawings are left-sided. Modules and combinations can be mirrored from left to right.

Modules

Scale 1:100

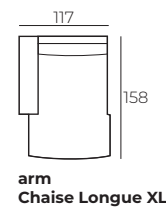
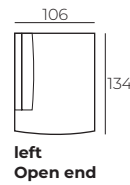
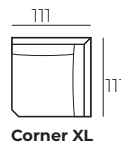
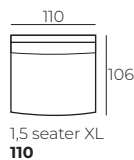
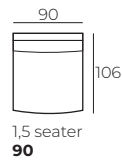
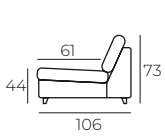

BLUEMARY

Modules with armrest

Scale 1:100

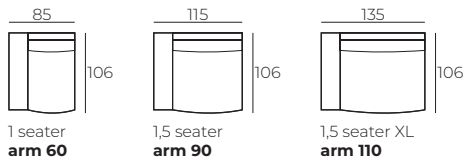

Combinations

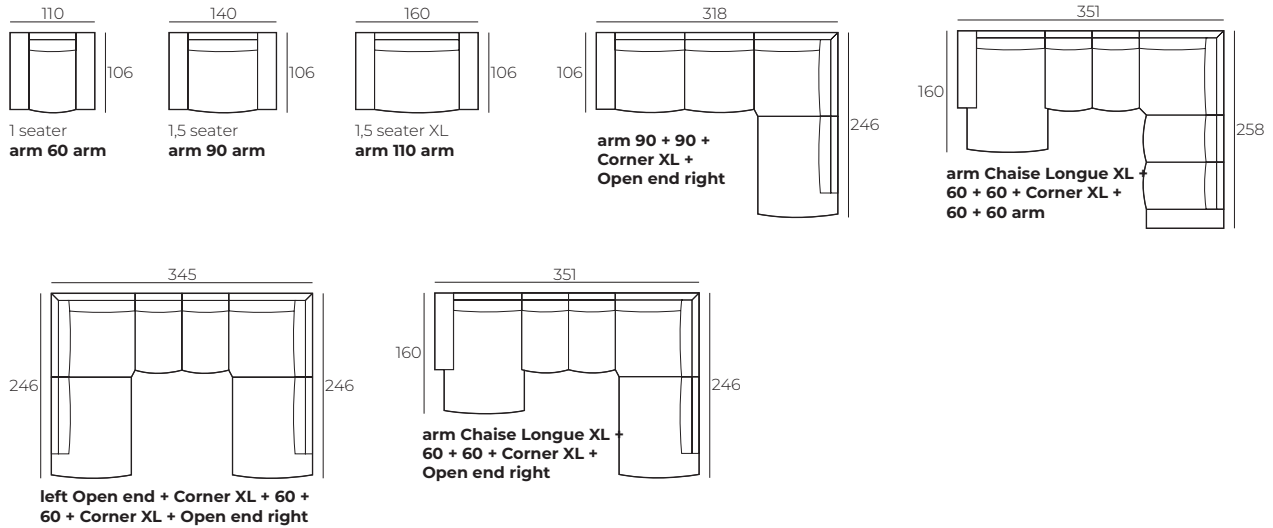

Accessories

